



NTSC U/C

PlayStation®



MONSTERSEED



SUNSOFT®

SLUS-00743
3114011

WARNING: READ BEFORE USING YOUR PLAYSTATION® GAME CONSOLE.

A very small percentage of individuals may experience epileptic seizures when exposed to certain light patterns or flashing lights. Exposure to certain patterns or backgrounds on a television screen or while playing video games, including games played on the PlayStation game console, may induce an epileptic seizure in these individuals. Certain conditions may induce previously undetected epileptic symptoms even in persons who have no history of prior seizures or epilepsy. If you, or anyone in your family, has an epileptic condition, consult your physician prior to playing. If you experience any of the following symptoms while playing a video game – dizziness, altered vision, eye or muscle twitches, loss of awareness, disorientation, any involuntary movement, or convulsions – IMMEDIATELY discontinue use and consult your physician before resuming play.

WARNING TO OWNERS OF PROJECTION TELEVISIONS:

Do not connect your PlayStation game console to a projection TV without first consulting the user manual for your projection TV, unless it is of the LCD type. Otherwise, it may permanently damage your TV screen.

HANDLING YOUR PLAYSTATION DISC:

- This compact disc is intended for use only with the PlayStation game console.
- Do not bend it, crush it or submerge it in liquids.
- Do not leave it in direct sunlight or near a radiator or other source of heat.
- Be sure to take an occasional rest break during extended play.
- Keep this compact disc clean. Always hold the disc by the edges and keep it in its protective case when not in use. Clean the disc with a lint-free, soft, dry cloth, wiping in straight lines from center to outer edge. Never use solvents or abrasive cleaners.

WELCOME

Thank you for buying Sunsoft's
"Monsterseed" for the PlayStation®.

Please read this guide carefully
before use to find out how to play the game.
Keep the guide in a safe place for
future reference.

CONTENTS

Basic Controller Functions	5
Game Story	8
Starting the Game	9
In-Game Navigation	10
Menu window	14
Hatching Monsters	20
Fighting	22
Monster Album	29

INTRODUCING "MONSTERSEED"

"Monsterseed" is a new style of monster collection RPG (Role Playing Game), which requires you to hatch the seeds of monsters, and then summon your monsters and command them to fight for you. You take the role of Daniel, "The Ruler", who has the power to command monsters. You must raise different types of monster and venture through dungeons; fighting enemies and completing given tasks. As the Ruler, rather than fighting using weapons or magic, you summon your monsters to fight for you, so the monsters hold the key to victory. How effectively you raise monsters and send them into combat is the measure of your skill as a player. If you have separate memory cards, you can have a contest between original monsters. Enjoy the different adventures you may encounter as you follow the game storyline, and experience the fun of raising monsters and sending them into battle!

Console

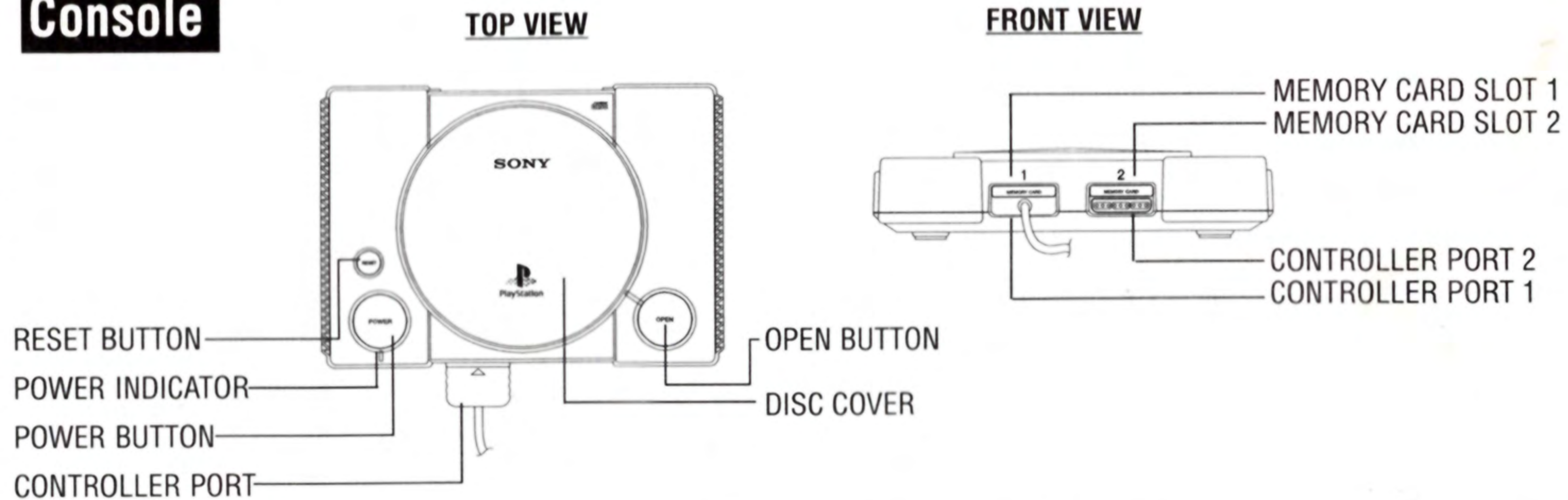

Set up your PlayStation® game console according to the instructions in its Instruction Manual. Make sure the power is off before inserting or removing a compact disc. Insert the MONSTERSEED disc and close the disc cover. Insert game controllers and turn on the PlayStation game console. Follow on-screen instructions to start a game.

USING THE CONTROLLER

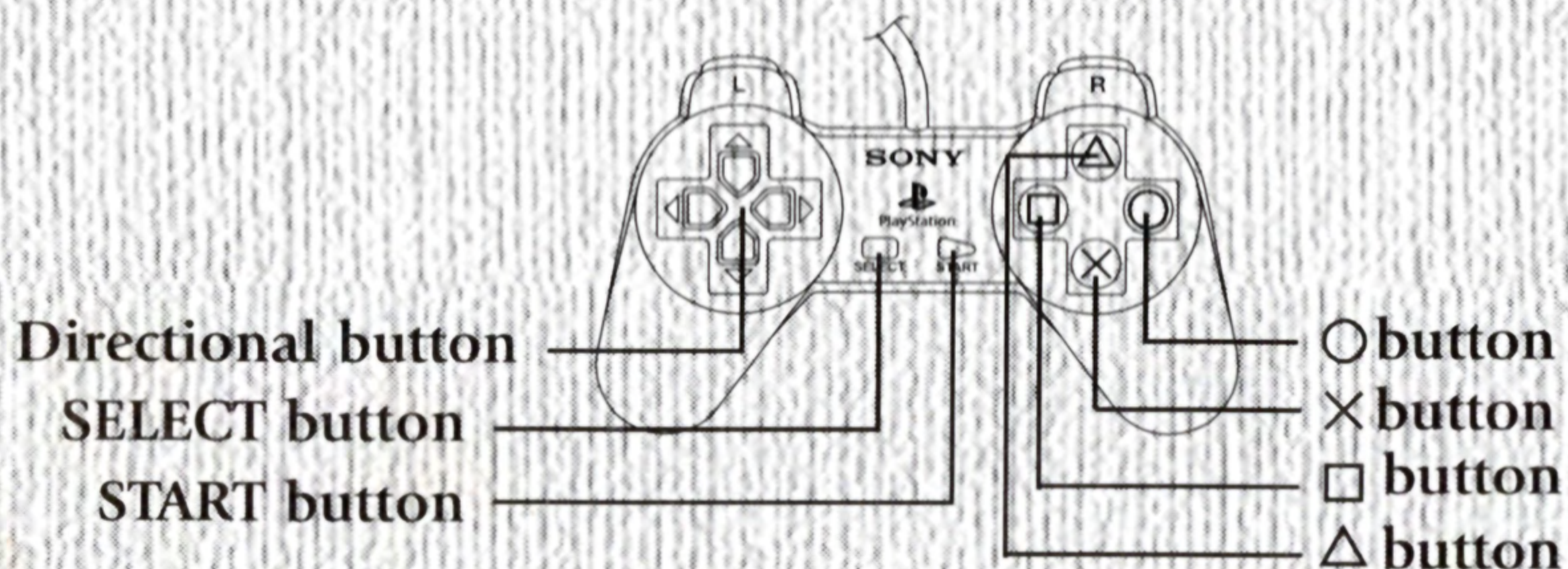
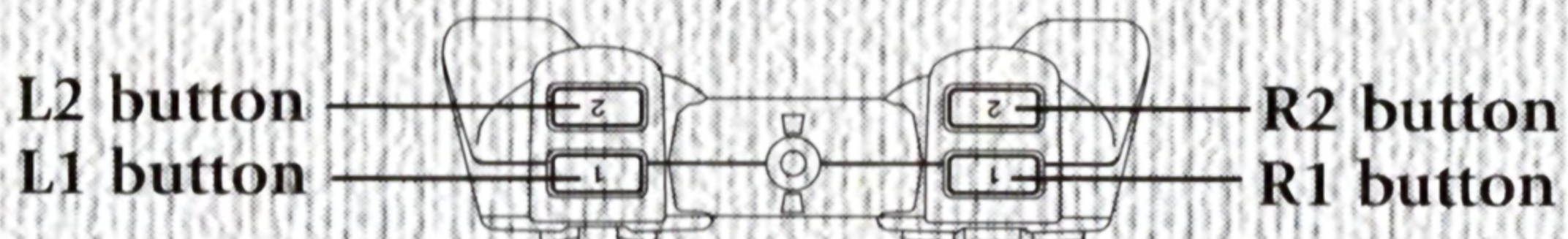

Moving through game field

Directional buttons	Move character/move cursor
X button	Actions such as decide, search, speak, take, etc.
△ button	Cancel
O button	See explanation of given command
Select button	See monster album
Start button	See status screen
<i>(When analogue control is on)</i>	
Left stick	Same action as directional buttons
L3 button	Same action as X button
R3 button	Same action as O button



USING THE CONTROLLER

In fight mode

Directional buttons	Select movement unit/move cursor
X button	Enter
△ button	Cancel
○ button	See explanation of given command. See status (during summons menu)
L1 button	Turn direction to left at that point (only when turning)
L2 button	Turn direction to right at that point (only when turning)
<i>(When analogue control is on)</i>	
Left stick	Same action as directional buttons
L3 button	Same action as X button
R3 button	Same action as △ button

In the store, controlling incubator, or in status screen

Directional buttons	Move cursor/change page
X button	Enter
△ button	Cancel
□ button	Choose solution (when controlling incubator only)
○ button	See explanation of given command. Change name (in status screen only)
Select button	See monster album
<i>(When analogue control is on)</i>	
Left stick	Same action as directional buttons
L3 button	Same action as X button
R3 button	Same action as △ button

ANALOG CONTROLLER

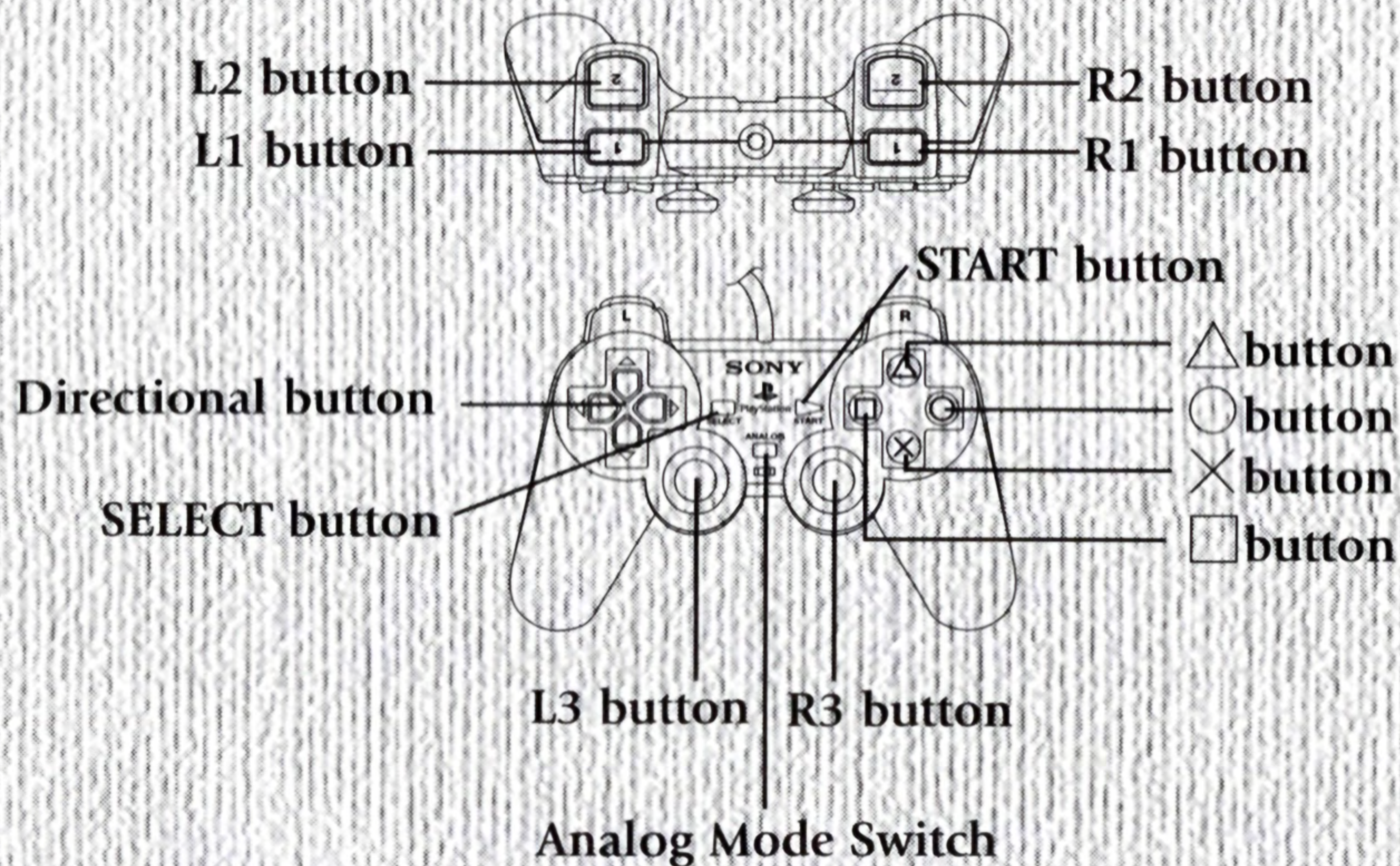

Analog Controller

This game is compatible with the input functions on a Dual Shock™ Analog Controller.

Analog input is only possible when the Analog Mode Switch display is lit. The controller changes to directional buttons input when the Analog Mode Switch is switched off.



GAME STORY

Deep in the South-eastern region of a far-off land, there lies a remote town called Len Bal.

A young man is walking down a mountain path towards this town.

His name is Daniel.

He is a Ruler and has been drawn to this place by rumours surrounding Jede's mine, where hundreds of monster seeds were discovered more than a decade ago.

Rulers like Daniel have special powers to summon and control monsters.

Since the discovery of the monster seed burial, the town of Len Bal has been seething with excavation work, but recently the site has been taken over by a band of thieves calling themselves the "Black Rope Gang", and all digging activity has stopped.

Daniel has yet to find this out. A journey of formidable adventures lies ahead of him.



STARTING THE GAME

At the title screen, the menu shown on the right is displayed.

Use the directional buttons to select an option and press the **X** button.

NEW GAME

Select this option when you want to start a new game.

CONTINUE

If you have saved data onto a memory card, then this option allows you to continue that game.

VS

If each player has a memory card, then you can play a monster vs. monster contest. Insert memory cards containing saved data into the Player 1 and Player 2 memory card slots.

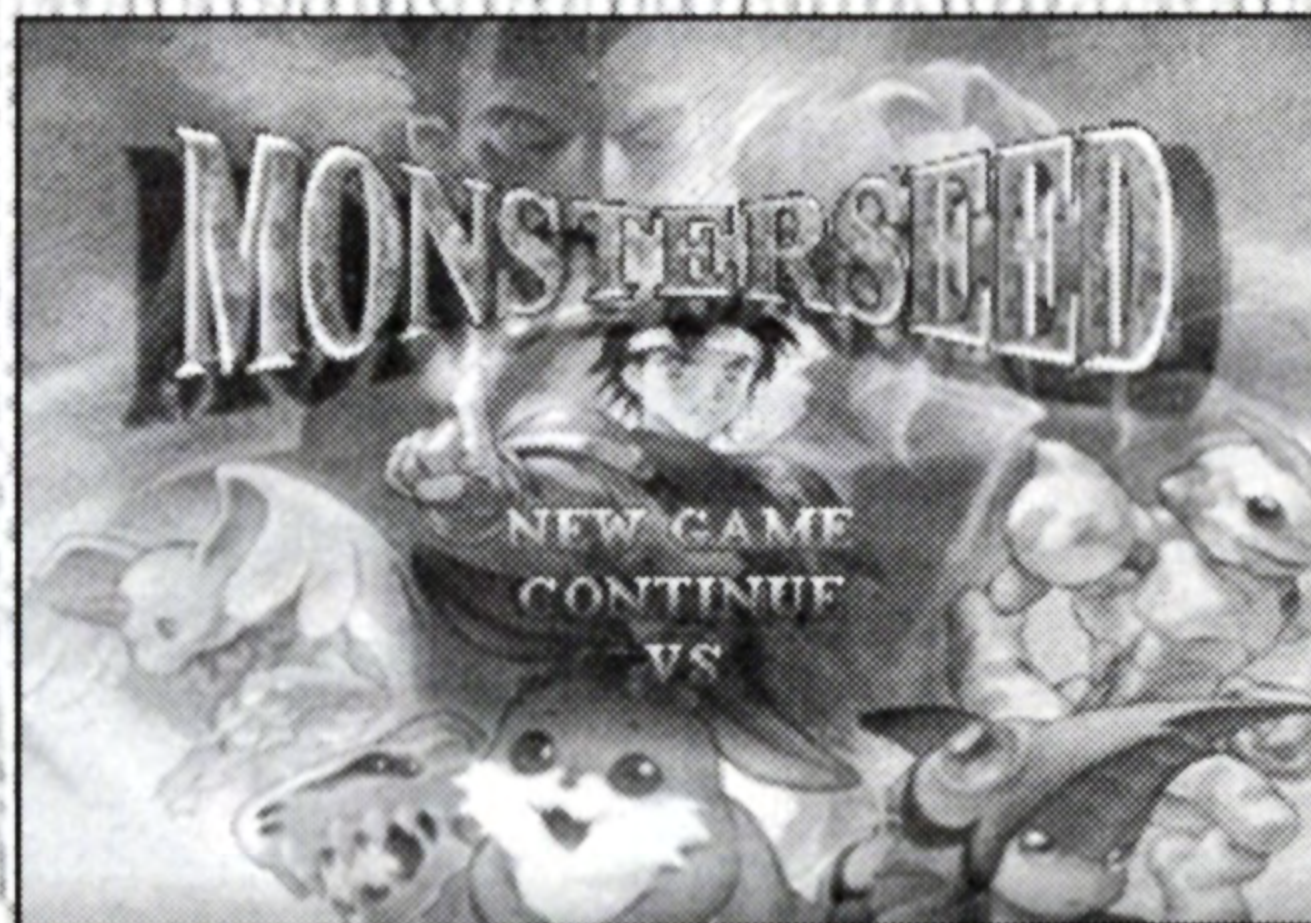

IN-GAME NAVIGATION

The character is moved using a general map and a movement map.

General Map

This map shows the general layout of the town. If you choose a destination on this map, you then enter a movement map. The number of destinations increases as the story unfolds. Select a destination using the directional buttons and confirm by pressing the **X** button.



Movement Map

This map is for moving your character and making him perform actions. There are many locations you can visit, such as shops and Inns in the town, and fortresses and mines outside the town.



IN-GAME NAVIGATION

Stopping at the “White Armor” Inn

Here, you can take a rest to regain your strength, or you can save the game.

How to save the game

Select “SAVE” from the Inn menu and press the **X** button. A file screen will appear.

Insert a memory card into the machine, select the file location you want to save the game to, and then press the **X** button or the L3 button. If you choose a file already containing saved data, you will be asked “Do you want to overwrite data?” If this is OK, press the **X** button or L3 button.

You can cancel your selection by pressing the **△** button.

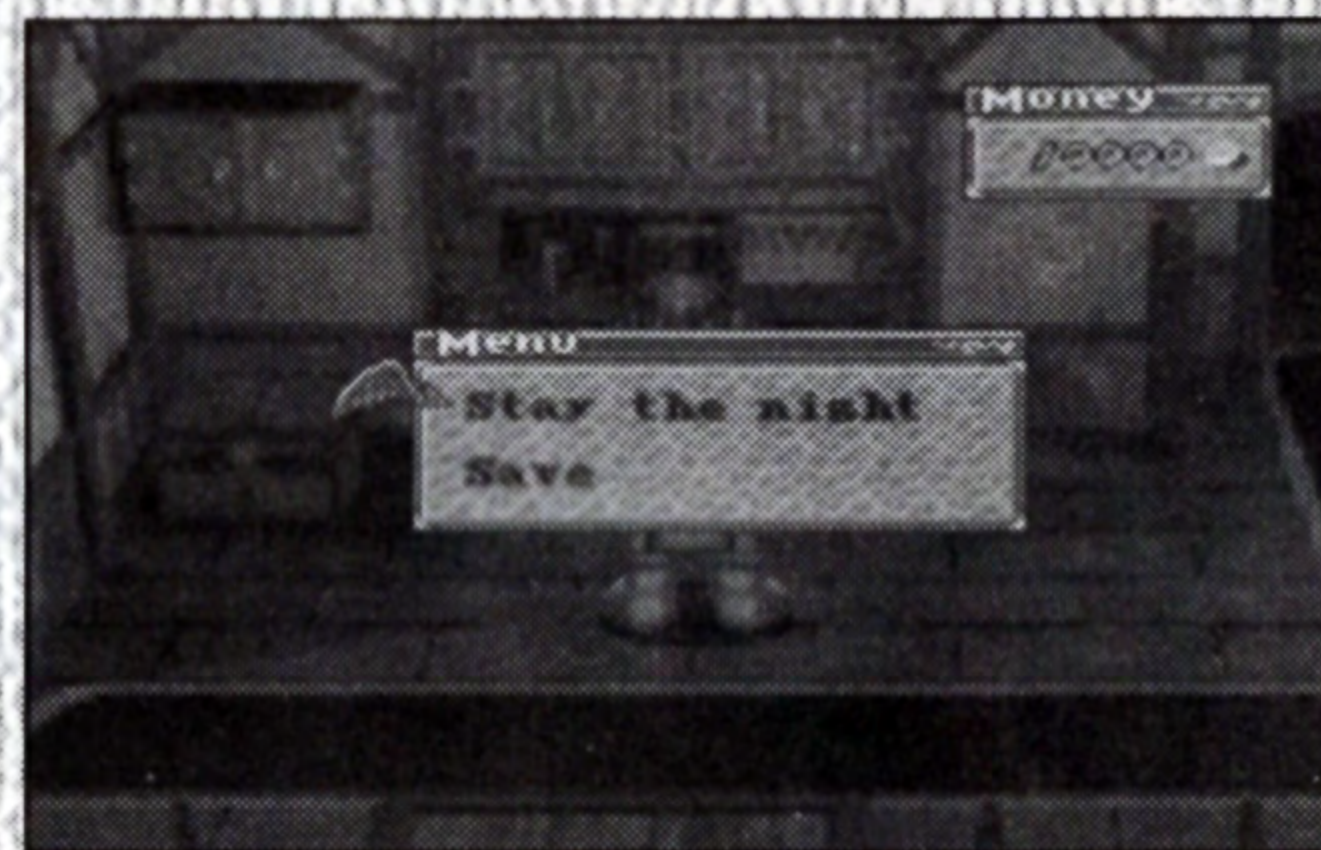
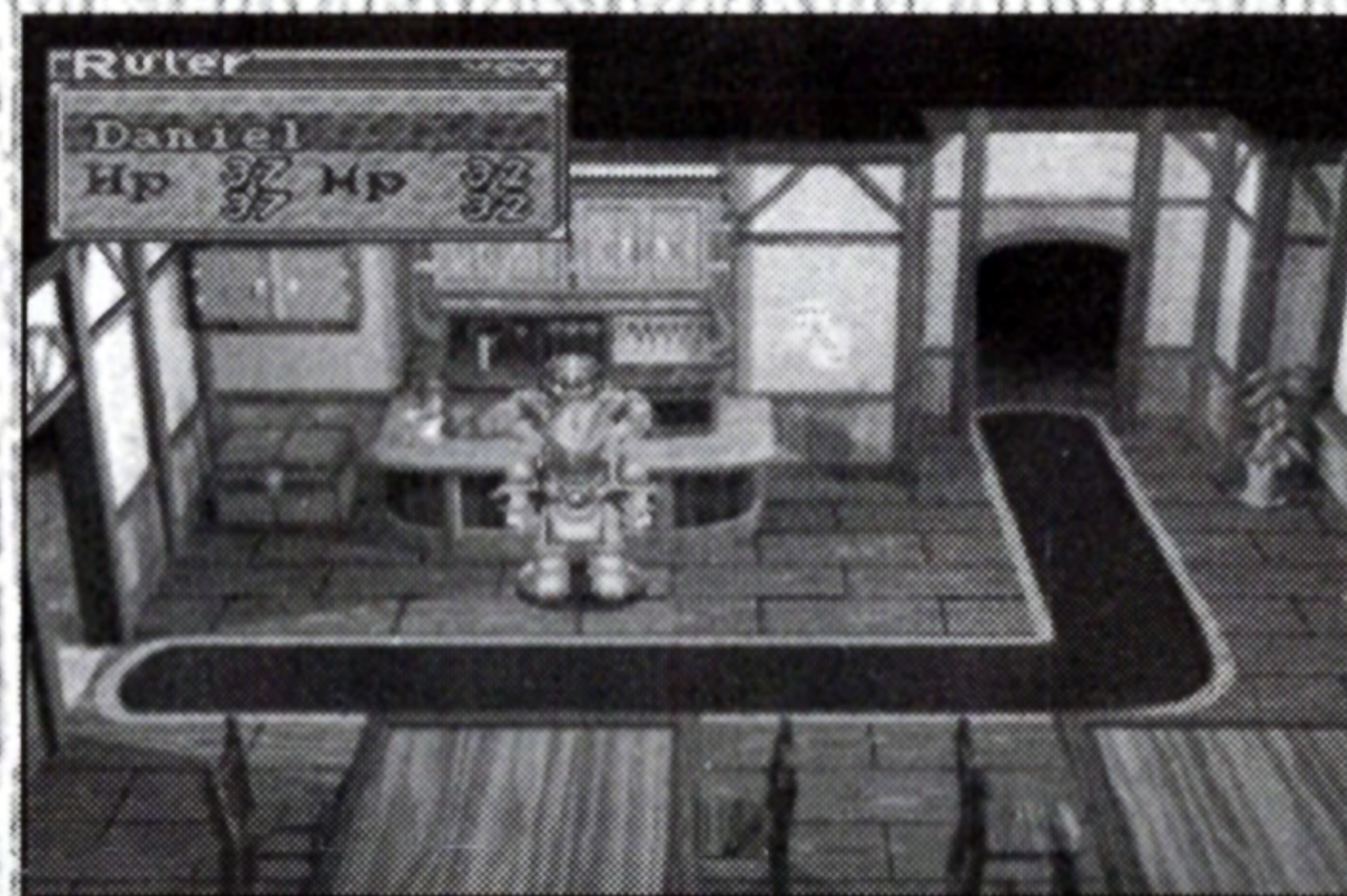

IN-GAME NAVIGATION

Morigan Department Store

In this store, you can buy and sell items. Choose an item you want to buy, using the directional buttons, and then press the **X** button. Next, press the directional buttons to specify the quantity and press **X** again. To see a description of an item, press the **O** button. You can sell items using the same controls.



Soulin Fighting Monster, Item Store

Here, you can use an incubator to hatch monsters and sell seeds and solutions. Monsters are bought and sold in the same way as items, so select a monster you want to buy from the monsters displayed and then press the **X** button. If you want to see a description of a monster or an item, press the **O** button.



IN-GAME NAVIGATION

To give a name to a monster you have bought, select letters using the directional buttons and input the name by pressing the **X** button. The cursor moves one step back if you press **△** and one step forward if you press **○**.

See page 20 “Hatching Monsters” for instructions on how to use the incubator.

Monster Fighting Ring

This is where the self-proclaimed rulers gather and compete for top ranking. If you win, you receive prize money and items.

Town Plaza

This is an important place where you can gather information, and you may be asked by the Town Chief to perform certain tasks. From the square, you can reach the house of Kal, a girl of about the same age as Daniel. Kal lives with her grandfather, Wolf, and her two pets.

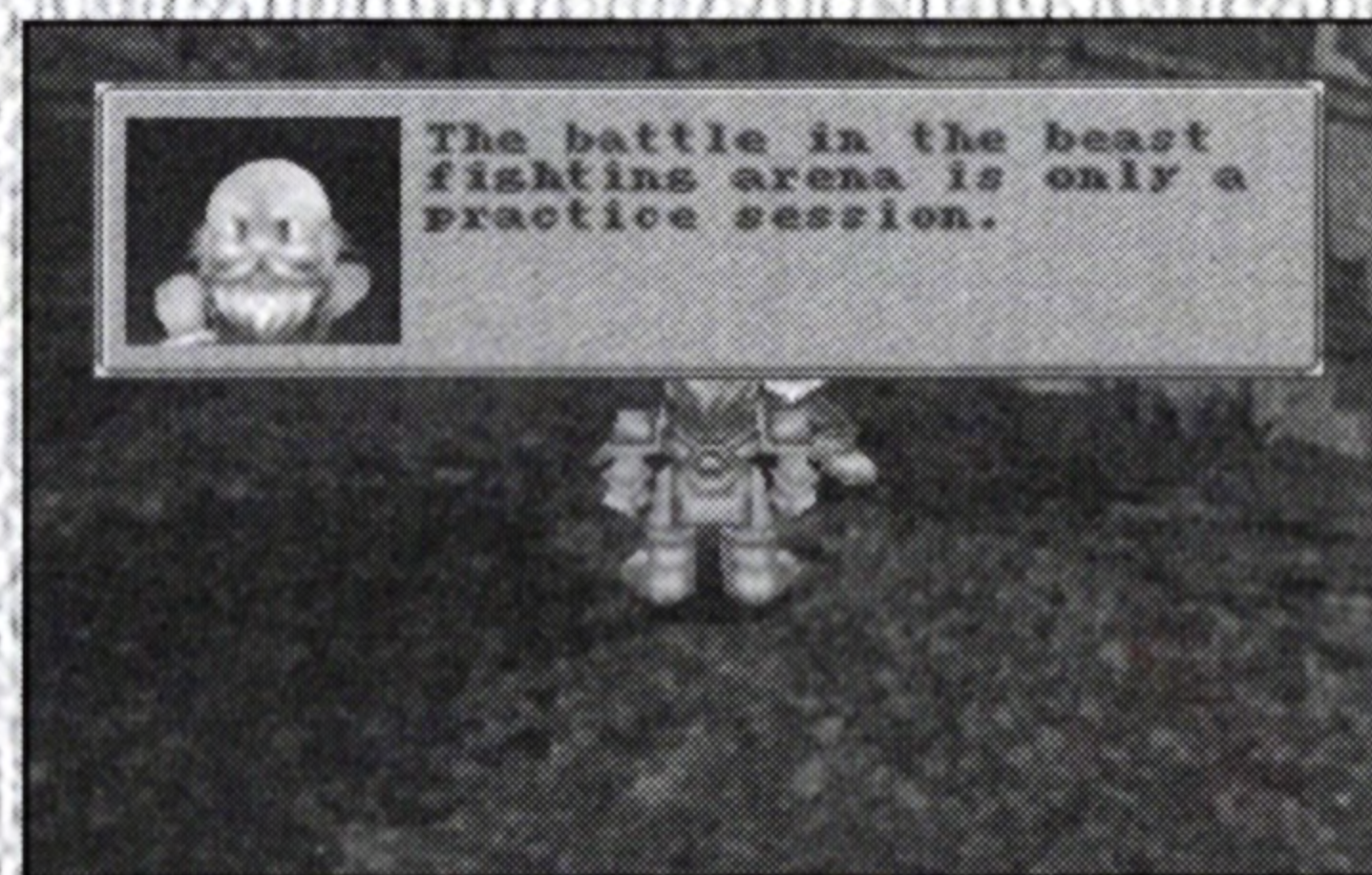

MENU WINDOW

When your character is able to move around and is not engaged in a fight, you can call up a menu window by pressing the Start button. Select the option you want and press the **X** button.

Status

This shows the status of the monsters owned by the Ruler. Select a character you want to know about from the list and press the **X** button. A status window will appear.

Character window

Graphic image of character.

Feature window (Merit window displayed by pressing right directional button)

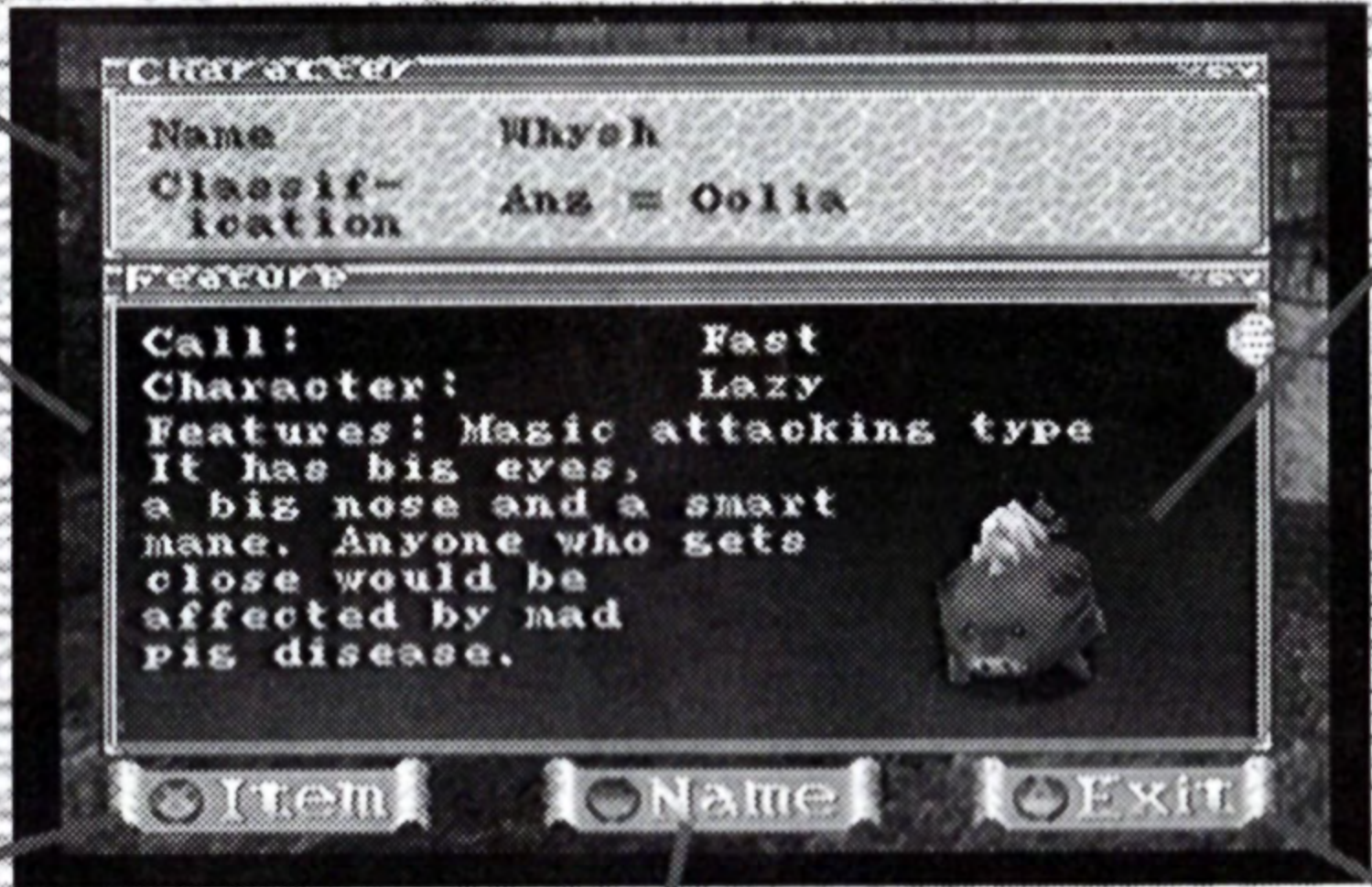

Monster items displayed by pressing **X** button (switch to Item window)

Change name by pressing **O** button

Exit screen by pressing **Δ** button



An "Item" command is not displayed on the Master status screen.

Character window

The name and type of character is displayed. You can change the name by pressing the  button.

Feature window

“Call” Shows the speed of the monster when summoned.

“Character” Tells you how the monster will behave during a fight and how loyal it will be to the Ruler.

“Features” Shows the monster’s method of attack.

“Comments” Describes other special features of the monster.

Merit window

“Status” Current status of the monster.

“Life force” The monster’s strength against physical attack. If it reaches 0, then the monster goes into a state of “apparent death” and cannot move.

“Spiritual strength” The monster’s strength against mental attack. If this is 0, then the monster goes into a state of “apparent death” and cannot move.

“Battling defense” The monster’s strength to resist physical attack.

“Spiritual defense” The monster’s strength to resist magic or status changes.

“Agility” When this score is high, the monster’s turn comes around more quickly and it can dodge enemy attacks more easily.

“Power of Action” This sets the number of stamina points. The higher this score, the more things the character can do during a turn.

Status changes during a fight are reversed when the fight ends, except when the monster is in a state of “apparent death” or has been petrified.

If an item is used to change the character’s status, this change is not reversed until the monster dies.

The life force and spiritual strength of the Ruler do not return to their previous values at the end of a battle.

Types of Status Change

“Poisoned” The monster has been given poison, so each time it performs an action, the poison works on its body, causing damage and sometimes death.

“Blindness” The monster loses its sight, so its actions are limited.

“Madness” The monster is mentally confused and may even attack its own allies.

“Paralysis” The monster is paralysed and cannot move. It recovers as time passes.

“Coma” The monster falls asleep and cannot move. It wakes up after a certain amount of time has passed.

“Faint” The monster falls over and cannot move. It recovers as time goes by.

“Petrification” The monster is petrified and cannot move. After a certain time, it dies and disappears. Any monster which has been turned to stone will vanish at the end of a fight.

“Apparent death” The monster is on the verge of death. As time passes, it will die and disappear. Any monster in a state of apparent death at the end of a battle will vanish from the game.

The higher the monster’s Spiritual defence, the better it is at resisting status changes. Also, status changes can be cured by using particular items or magic.



Resistance

This window shows the monster's resistance to different elements. This resistance reduces the damage caused by a magic attack, depending on the element used in the magic.

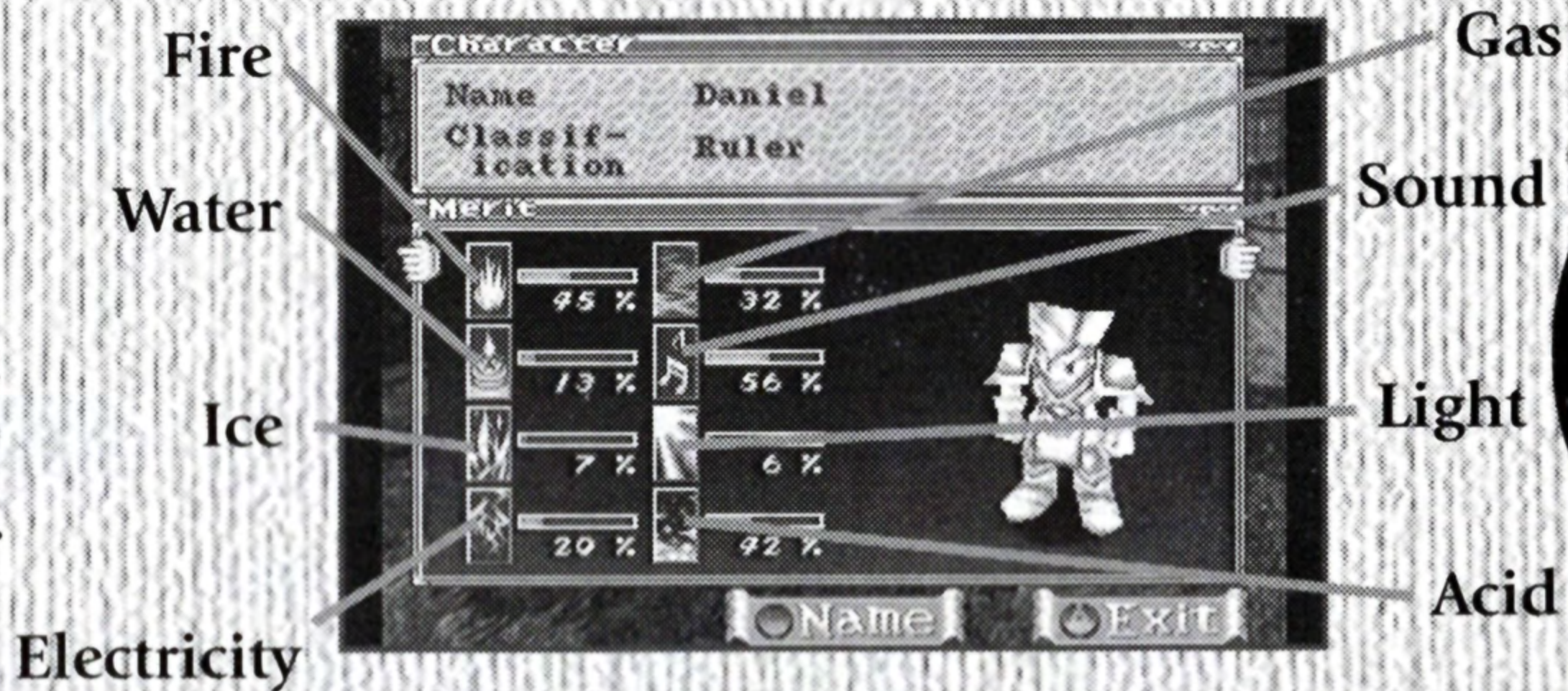

Attack / Magic window

This window shows the attacks and magic that the monster can use.

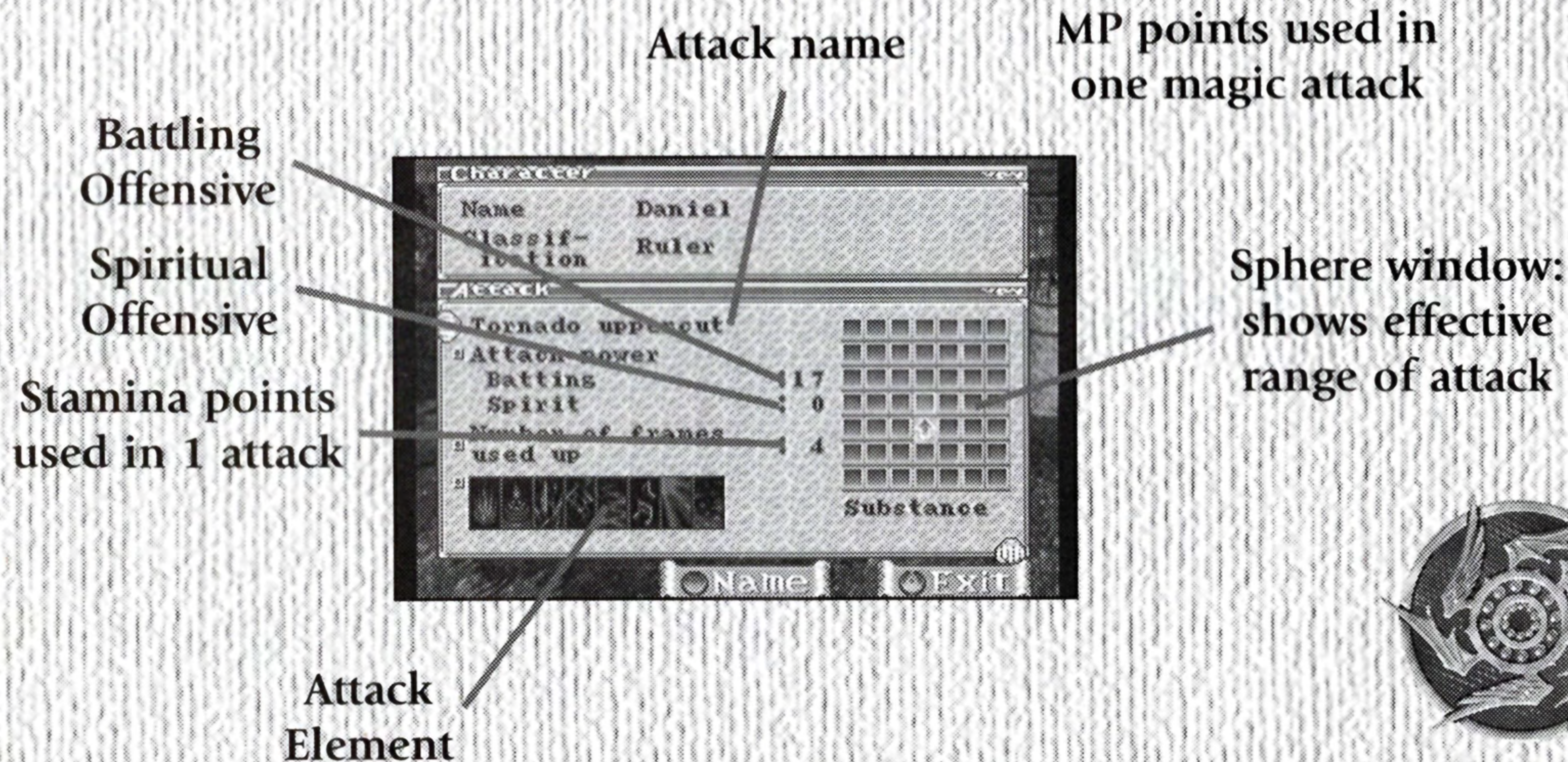

Monster Types

“Battling Offensive” Mainly attacks the life force of an opponent using physical attack.

“Magic attack” Mainly attacks the life force of an opponent using magic attack.

“Magic assist” Recites magic which restores life force and status.

“Tormentor” Recites magic which changes status or reduces ability score.

“Magician” Can use items to learn new magic.

“Floater” Can float over areas where there is nothing to walk on.

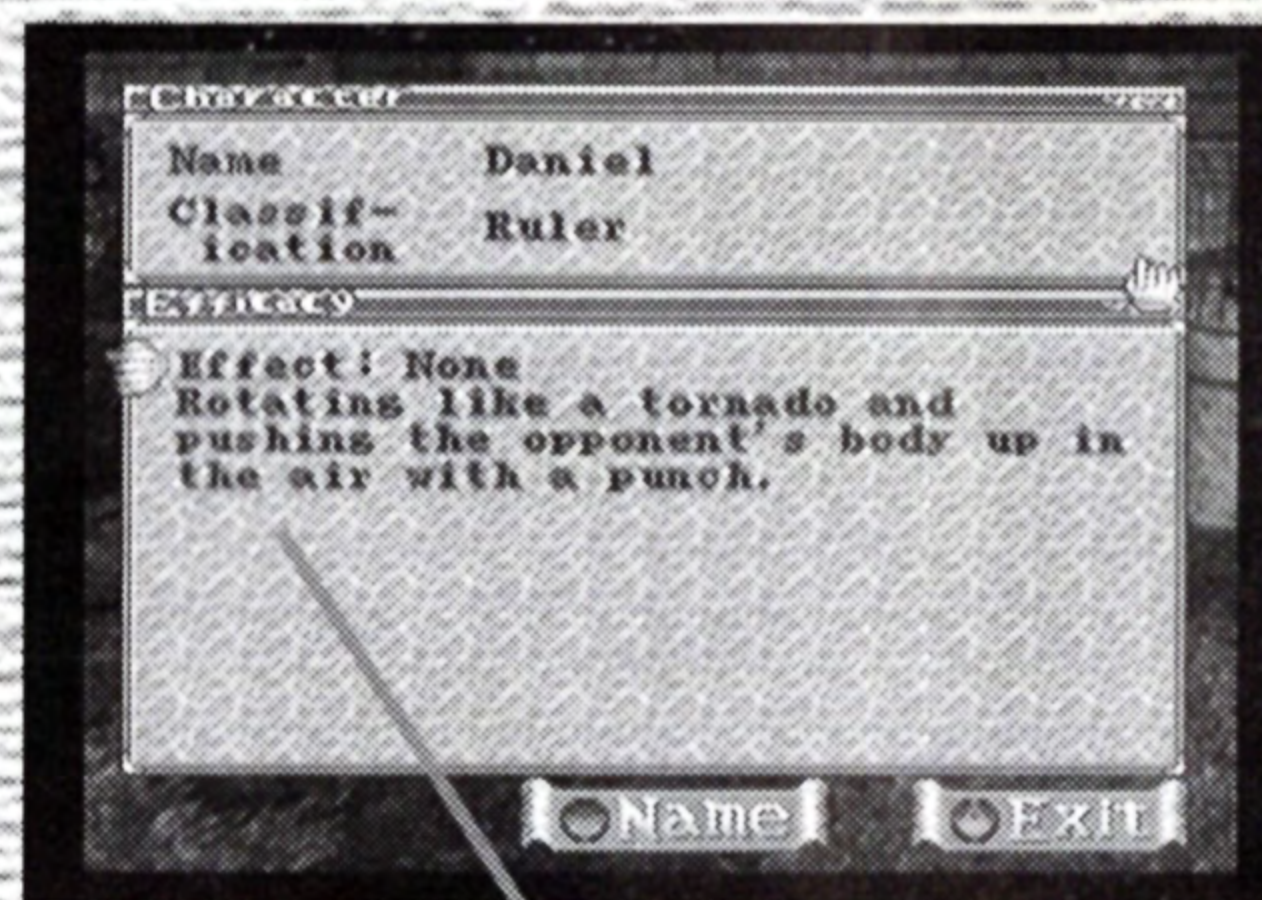

Efficacy window:
describes the effect
of that attack

Item window

This window shows the items that a monster can use. You can change the status or resistance of a monster using these items. However, the items have side effects, so an item can improve one area of a monster's status, but it may also harm another area of its status.

Select the item you want to use from the menu, press the **X** button, and you will be asked “Do you want to use XXXX (the item you have chosen)?”

If you agree, press **X** again. Use the **△** button if you want to cancel your choice.

You can see a description of the item by pressing the **O** button.

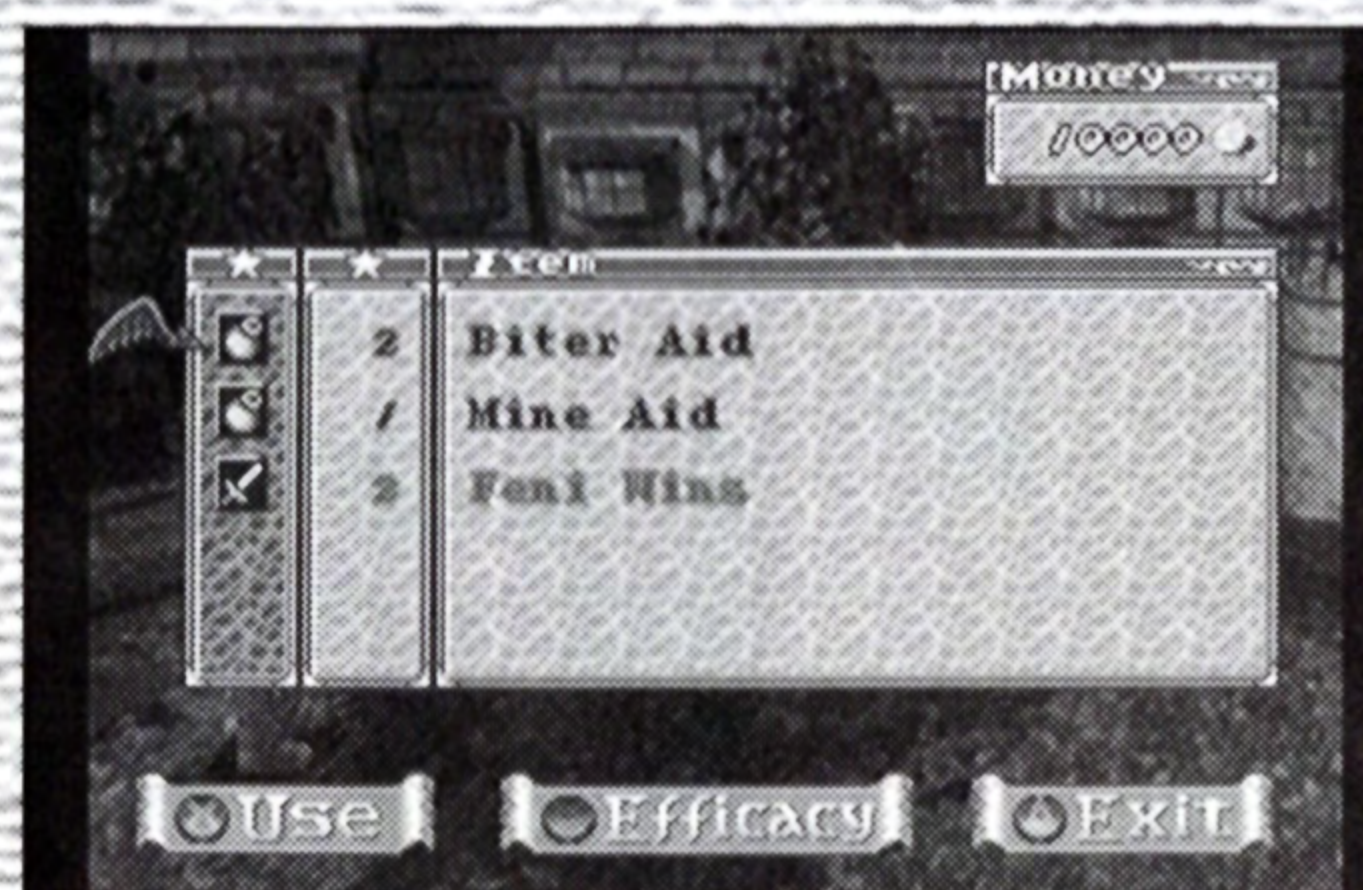

Items

The items owned by the Ruler are displayed so that they can be used. Items shown in pale text cannot be used.

Select an item you want to use from the menu and press the **X** button. A prompt asking “Do you want to use XXXX (name of item you have chosen)?” will appear. If you agree, press **X** again. To cancel your selection, press the **△** button. To see a description of the item, press the **O** button.

Seeds

This shows the monster seeds that you own. Press the **O** button to bring up a description of the seeds.

Solution

This screen displays the solution in your possession. Press the **O** button if you want to see a description of the solution.

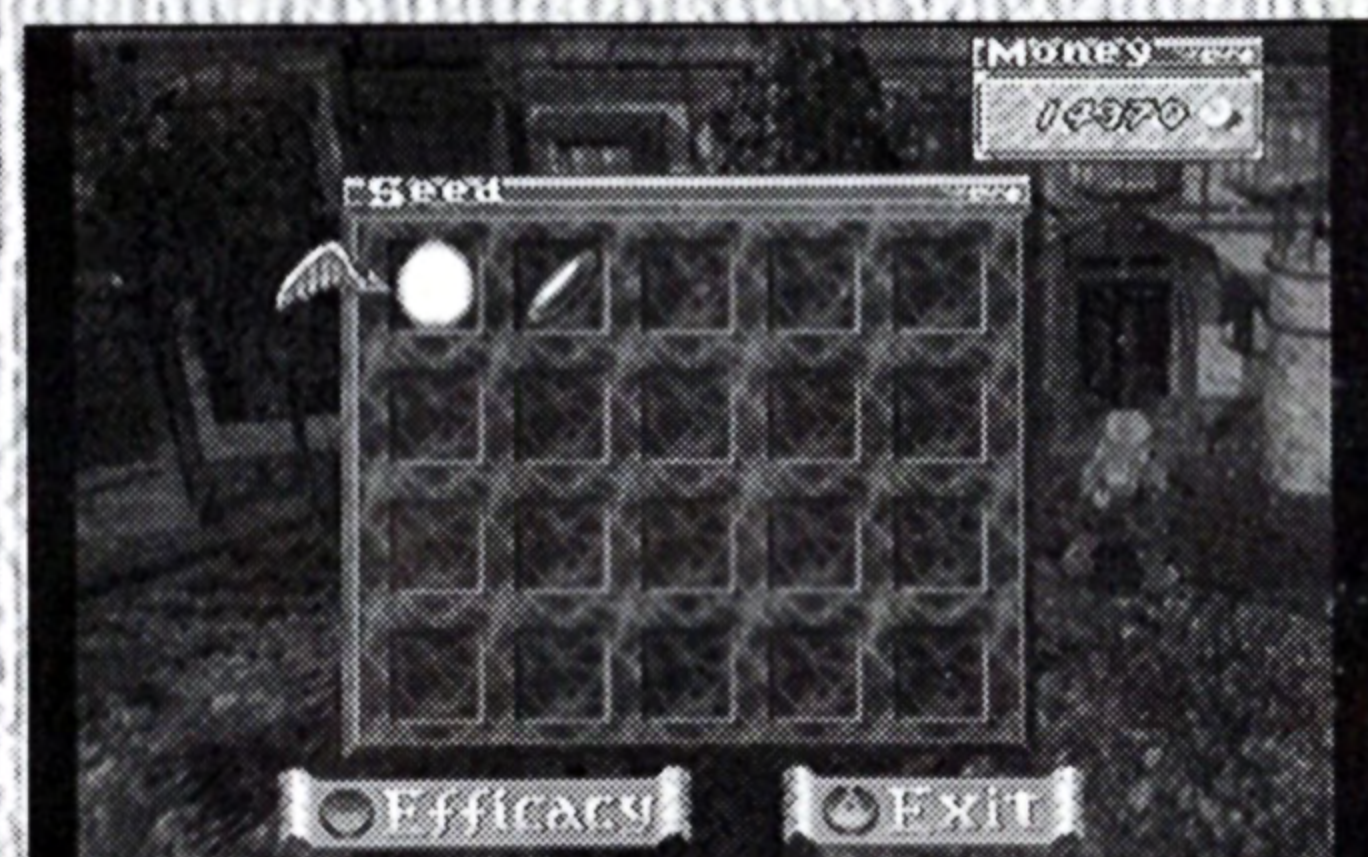

HATCHING MONSTERS

By choosing to use the incubator at the Soulin Fighting Monster, Item Store, you can hatch your monster seeds to produce monsters.

(1) Place the monster seeds you want to hatch in position. Use the directional buttons to select the seeds to hatch and then press the **X** button. To see a description of the seeds, press the **O** button.

(2) Select the solution you want to add to the seeds. You can toggle between "Select" and "Cancel" by pressing the **□** button. Once you have made your choice, press the **X** button to confirm.

Press the **O** button if you want to see an explanation.

(3) Select the temperature setting. The type of monster produced will vary depending on the temperature. Use the directional buttons to select a temperature and then press the **X** button.

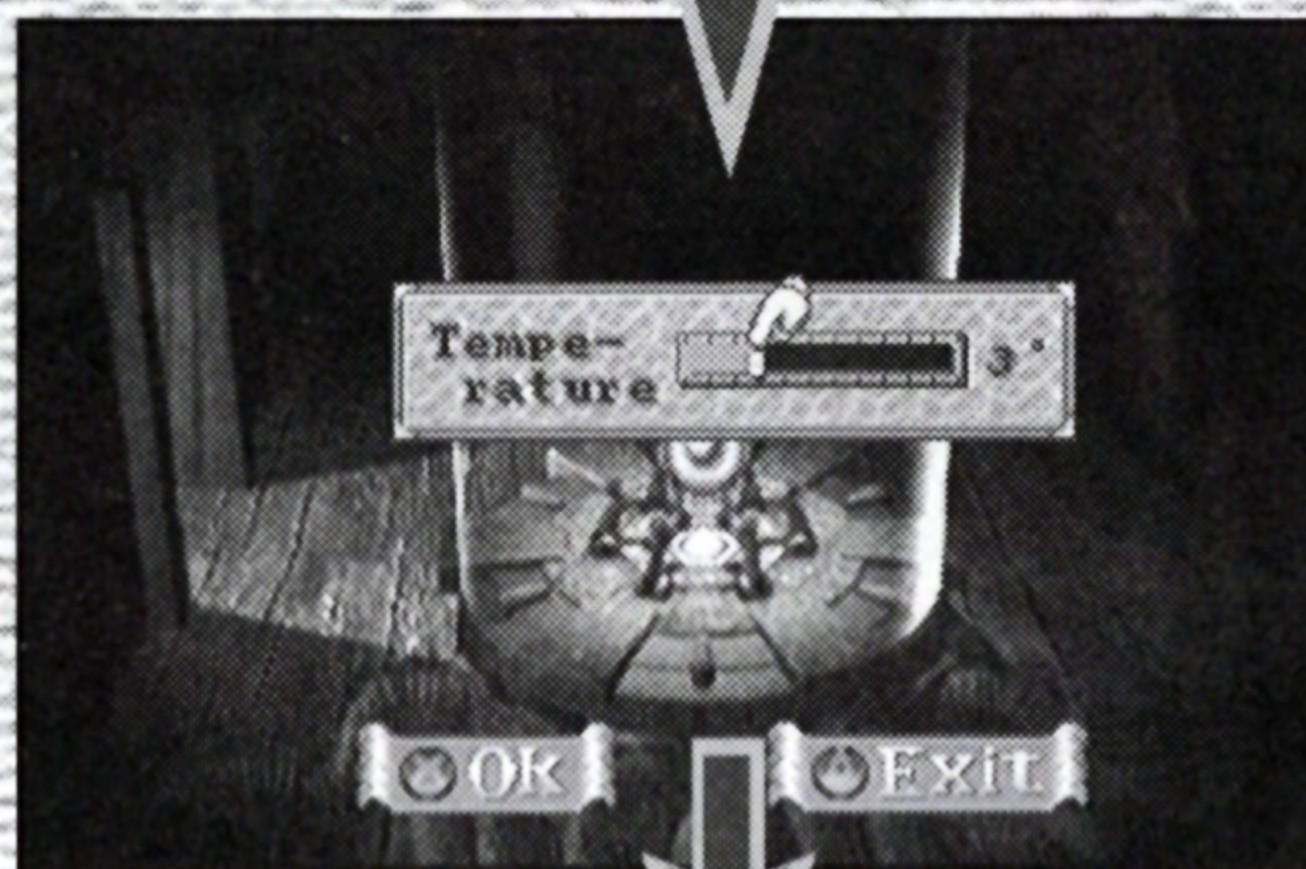

HATCHING MONSTERS

(4) The monsters will hatch out and their status will be displayed.

(5) Give a name to each hatched monster.

Use the directional buttons to select letters and press the **X** button to enter the name. The **O** button moves the cursor one step forward and the **Δ** button moves it one step back.

In stages (1) - (3) of the menu, you can open the seed page of the monster album by pressing the Select button.

What is a “Seed”?

This is the seed of a monster. The type of seed you use decides the type of monster that is produced. For example, you cannot hatch a “tormentor” monster from the seed of a “magic attack” monster.

What is the “Solution”?

This is a liquid, which alters the status of the monsters, depending on the type of solution used. For example, if a seed has poor life force, this weakness can be overcome by placing the seed in a solution which reinforces life force.

What is “Mutation”?

Sometimes, a mutant monster may be hatched. This is a monster which has completely different abilities or magical powers. So check the status of your seeds before you incubate them!



FIGHTING

If you encounter enemies or monsters as you are travelling through the movement map, you will be launched into the combat field. You and your opponent takes turns to fight. When it is your turn, you can perform an action and use up a set number of stamina points. Stamina points are points you use for performing actions. You will consume a set number of stamina points depending on the action you take.

Movement – 1 stamina point

You can move the Ruler in any directional. When it is your turn, the screen shows the following zones which you can move to.

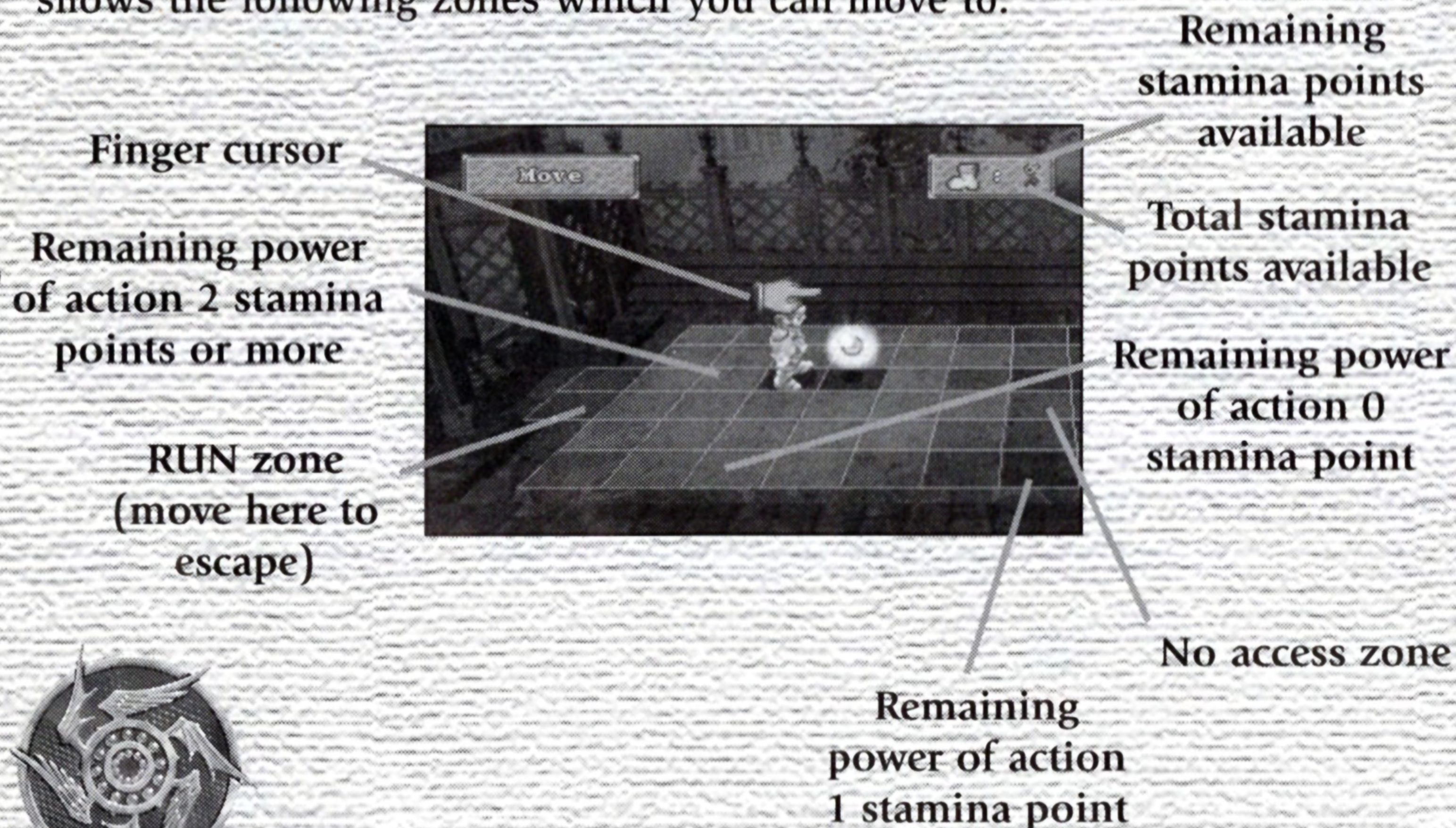

FIGHTING

Move the finger cursor to the place you want to move to, set the direction your character is to face using the L1 or R1 button, and then press the **X** button. If you still have any power of action left, the Action window will open and you can select another action. If you do not have any power of action left, your turn ends.

If you place the finger cursor over the Ruler before moving and then press the **X** button, the Action window will open.

Changing direction alone uses up one stamina point.

Action Window (Fight Menu)

Select the option you want and press the **X** button

Attack – 4 stamina points

The Ruler launches an attack

Wait – 0 stamina points

Your turn ends

Summons – 1 stamina point (per monster)

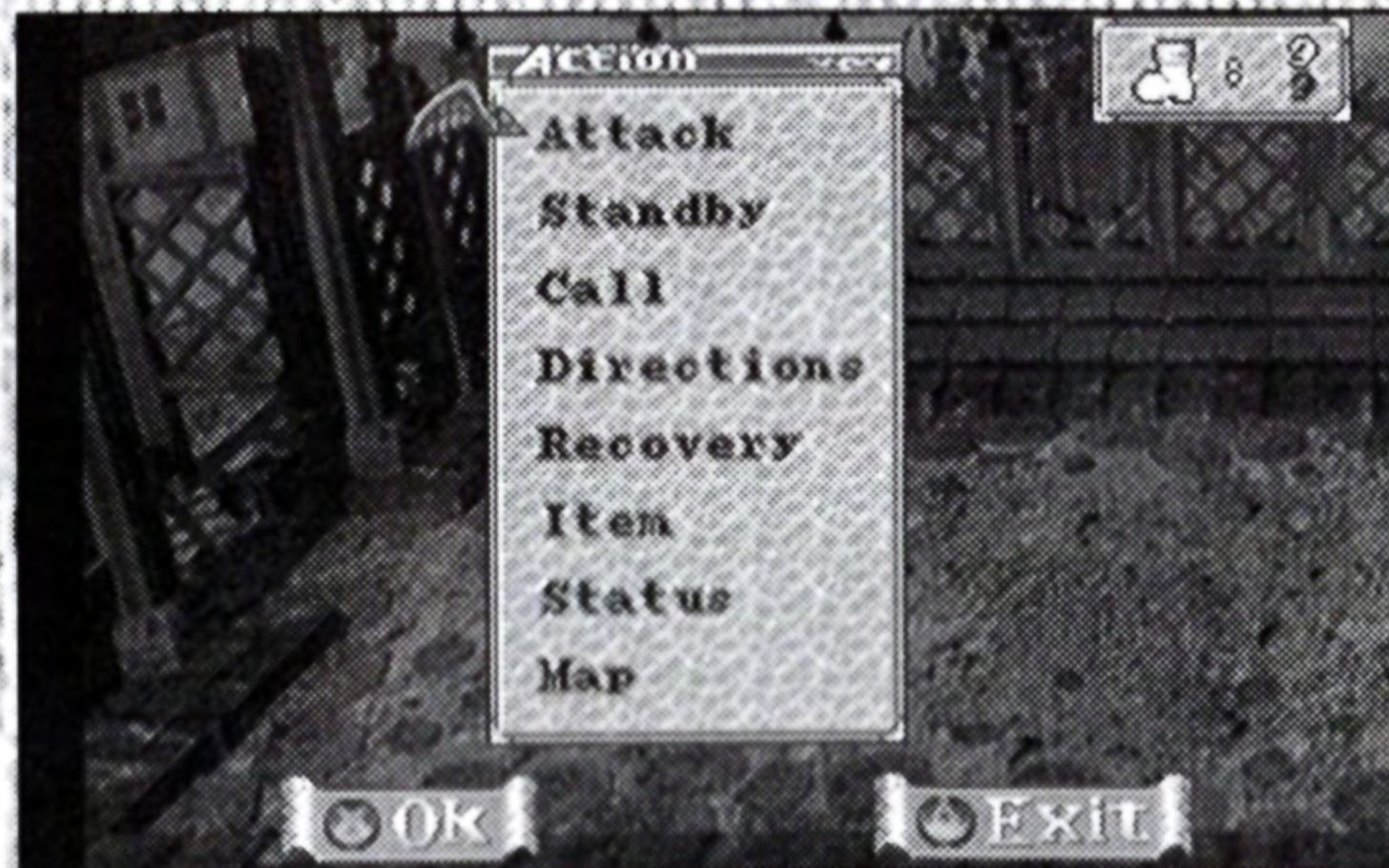

FIGHTING

On the fight map, you can summon monsters (up to a maximum of three)

(1) Select the monster(s) you want to summon from the monster list, and press the **X** button. You can check their status by pressing **O**.

(2) Place the cursor over a zone which a monster can be summoned to, and press the **X** button. A ball of light will appear.

(3) After a set amount of time, the ball of light will turn into a monster and the summon operation will be completed.

The time taken for the summons to be completed varies depending on the type of monster, but generally, the stronger the monster, the longer it takes.

Occasionally, your summon action may fail to call up a monster.

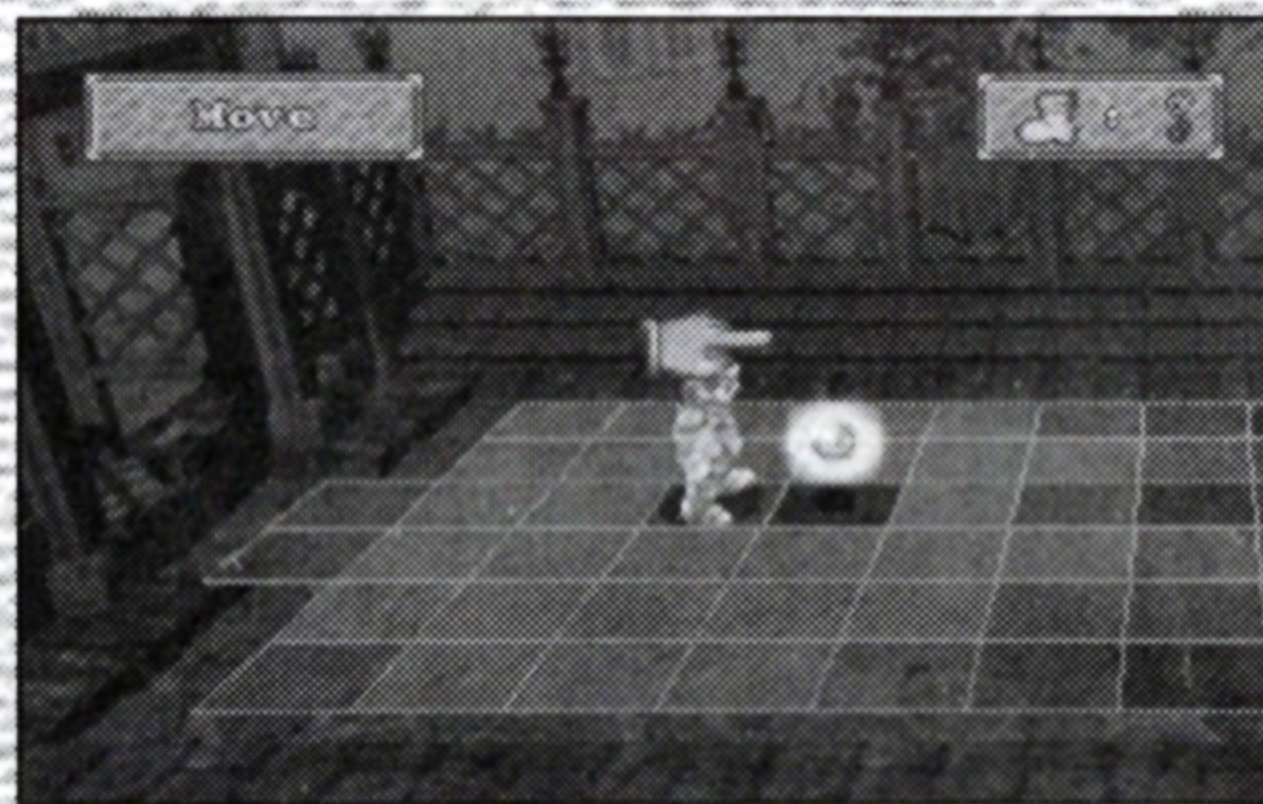

FIGHTING

Command – 1 stamina point (per monster)

You give a command to one of the monsters you have summoned. When you choose this option, an Indicate window (command menu) opens up. Select the option you want and press the **X** button. If there is more than one monster present, place the cursor over the monster you want to command and then press the **X** button.

“Attack” Attack the most suitable target.

“Suicide” Attack the enemy ruler.

“Defense” Attack the enemy character nearest to the Ruler. If there is no enemy near the Ruler, protect the Ruler.

“Assistance” Improve recovery or ability. If neither of these is possible, then “Retreat” is selected.

“Retreat” Move to place where monster can recover easily.

Commands and the Monster’s Personality

Depending on the monster’s personality, it may forget a command, or ignore it and take its own course of action. In situations like this, you must match your commands to the monster’s personality, whilst keeping your basic objective in mind.

“Brave” Rushes eagerly into battle

“Cowardly” If its physical force falls below 50%, it loses courage and turns to defending the Ruler.

“Lazy” Liable to wander off home.



FIGHTING

Withdraw – 1 stamina point (per monster)

This command instructs the monsters you have summoned to retreat. The range to which you can withdraw monsters is the same as the summon range. However, in some situations, they may not be able to retreat due to status changes (e.g., if the monster is in a state of apparent death or has been turned to stone, etc.)

After withdrawing some monsters, you can still summon other monsters.

Item – 1 stamina point

This window lets you use one of the items you own. When you select this option, an item list is displayed. Choose the item you want to use and press the **X** button. You can see a description by pressing the **O** button.

When you have selected an item, its effective range is shown in red on the map. If the target that you want to use the item against is within this range, place the cursor over the target and then press **X** button.



FIGHTING

Status – 0 stamina points

You can verify the status of all characters present on the combat field, both friendly and enemy. Place the cursor over the character you want to know about, and then press the **X** button.

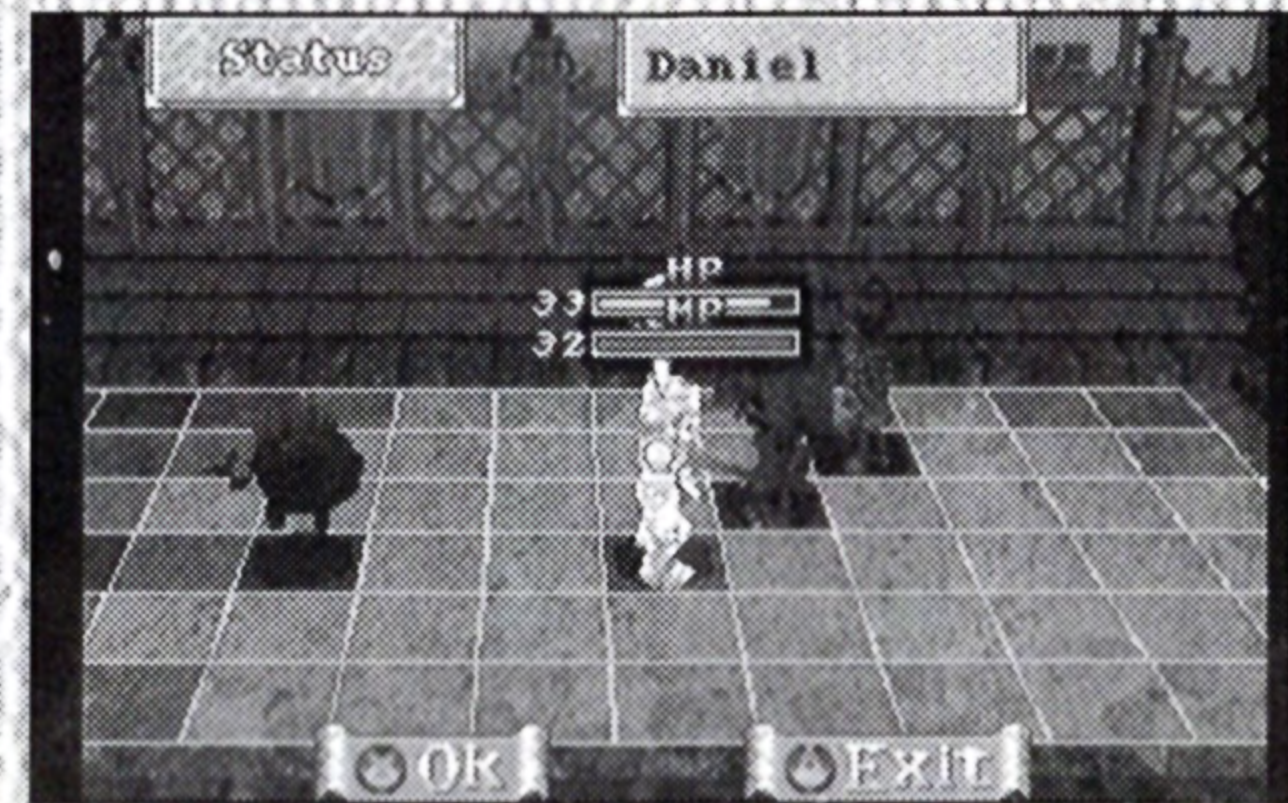

< HP > Life force remaining.

< MP > Spiritual strength remaining. This force is consumed when magic is used. If it reaches zero, the character is in a state of apparent death and cannot perform any actions.

Map – 0 stamina points

With this function, you can check the field of combat map. Press the directional buttons or the L1 or R1 buttons to scroll the map on the screen.

Outcome of battle

The result of a battle is decided in the following way.

“Victory” If you defeat the enemy ruler.

“Escape” If either ruler escapes from the field of combat. (If you move to the “pink zone”, this is regarded as an “escape”.)

“Defeat” If the Ruler is defeated.

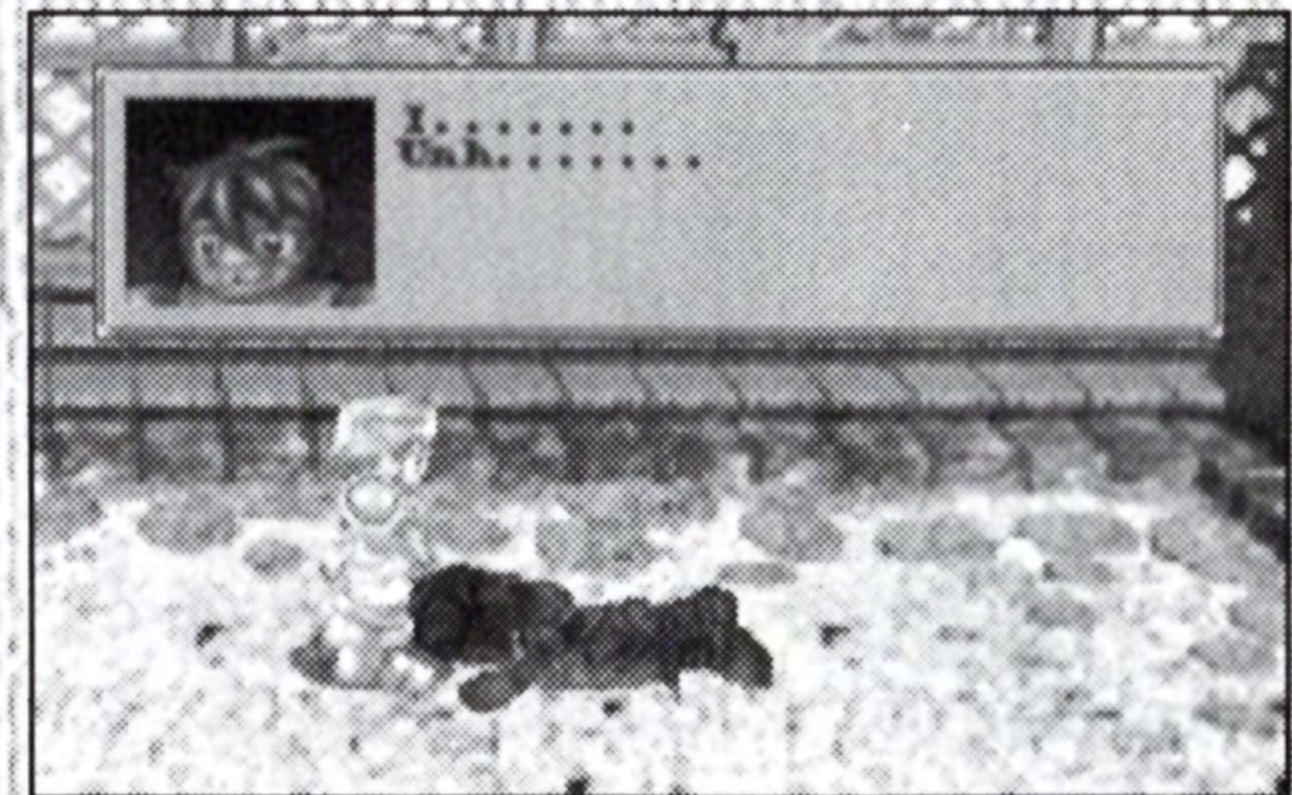

FIGHTING

Battling force and damage

Attacks are divided into the three categories given below and the battling force and defensive force for each type of attack are as shown.

Ability value used	Battling offensive	Battling defensive
Attack on life force	Spiritual offensive	Spiritual defensive
Attack on spiritual strength	Attacking force	Defensive force
Other attack	(other)	(mental)

When a battling offensive is made, the computer uses the agility score of the character under attack to judge whether or not it avoids the attack.

The damage suffered is a random number based on the attacking force minus the defensive force. However, when the target character is attacked from behind or when the target cannot move, the defensive force is zero. If the damage value is negative, then it is changed to a small value of 4 points, or so.

If an element is used in an attack, and the character under attack has resistance to that element, then the damage is reduced.

$(\text{Attacking force} - \text{Defensive force}) \times (100 - \text{Resistance value})$



MONSTER ALBUM

The monsters you have hatched are recorded in a monster album. This allows you to see which seeds monsters were hatched from, and also the temperature setting at which they were incubated.

If you press the Select button when your character is movable and not involved in a battle, then the front cover of the monster album will be displayed. Select either "Monster" or "Seed" and press the X button.

Monster

This option displays a list of all the monsters you have commanded. Select the monster you want to know about and press the X button. A description of that monster will appear, along with a table showing the seed and temperature used to hatch that monster.



MONSTER ALBUM

Seed

A list of seeds is displayed. If a seed has been used, a picture of it is shown. A [?] mark is shown in the number frame for each unused seed. Select the seed you want to see and press the **X** button. An incubation table is displayed for the selected seed from 1B0 to 9B0.

A picture of a monster will be shown in temperature frames which have been used, and a [?] mark is displayed in unused temperature frames.

Select the monster you want to see and press the **X** button. A description of that monster will appear, along with a table showing the seed and temperature used to hatch it.

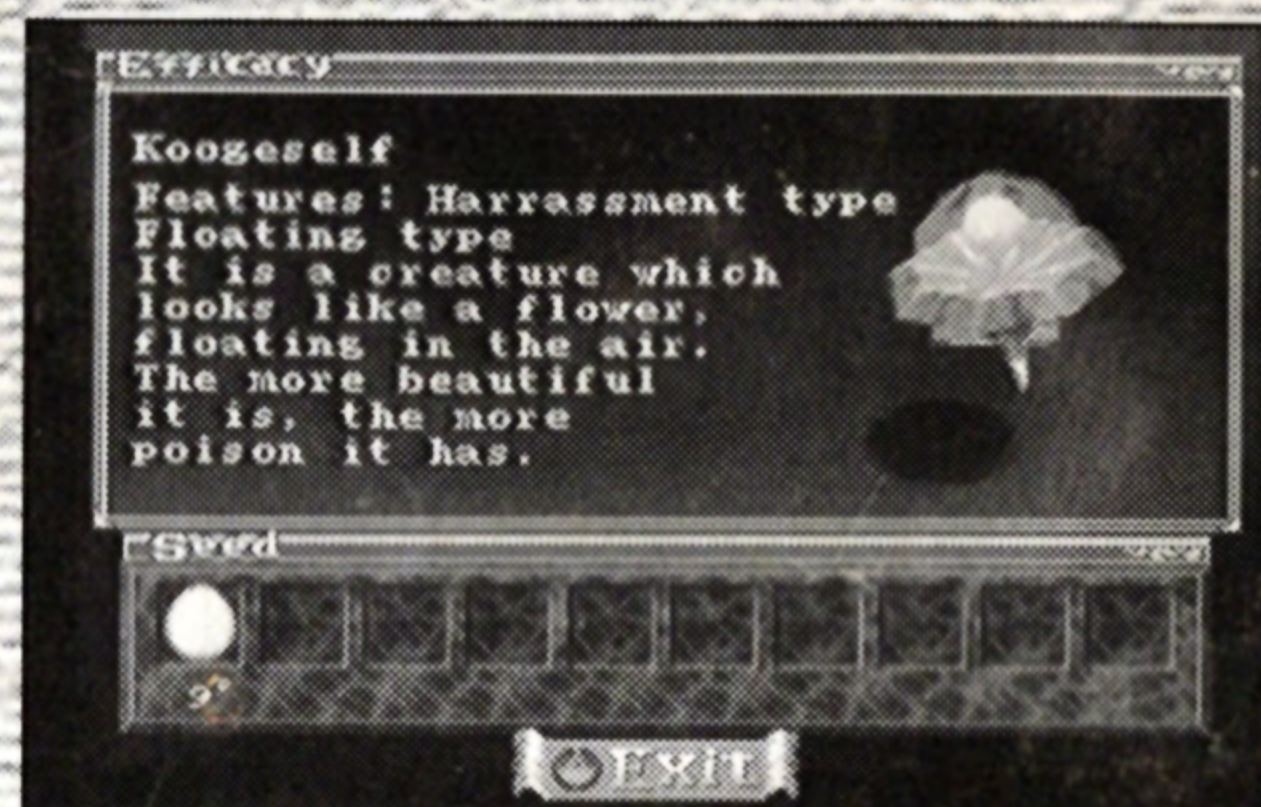
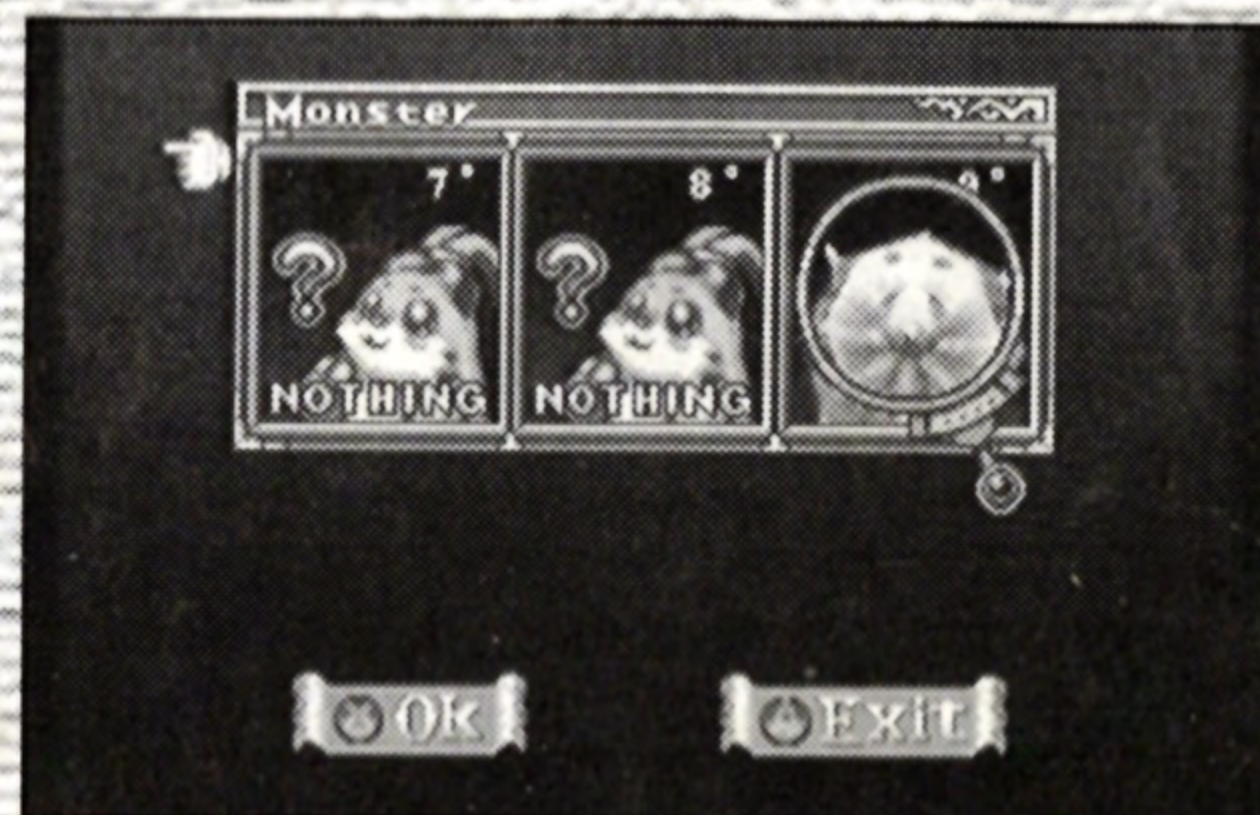

Sunsoft Limited Warranty

Sunsoft warrants to the original purchaser of this Sunsoft software product that the medium on which this computer program is recorded is free from defects in materials and workmanship for a period of ninety (90) days from the date of purchase. This Sunsoft software program is sold "as is" without express or implied warranty of any kind, and Sunsoft is not liable for any losses or damages of any kind resulting from use of this program. Sunsoft agrees for a period of ninety (90) days to either repair or replace, at its option, free of charge, any Sunsoft software product, postage paid, with proof of date of purchase, at its Factory Service Center.

This warranty is not applicable to normal wear and tear. This warranty shall not be applicable and shall be void if the defect in the Sunsoft software product has arisen through abuse, unreasonable use, mistreatment or neglect. **THIS WARRANTY IS IN LIEU OF ALL OTHER WARRANTIES AND NO OTHER REPRESENTATIONS OR CLAIMS OF ANY NATURE SHALL BE BINDING ON OR OBLIGATE SUNSOFT. ANY IMPLIED WARRANTIES APPLICABLE TO THIS SOFTWARE PRODUCT, INCLUDING WARRANTIES OF MERCHANTABILITY AND FITNESS FOR A PARTICULAR PURPOSE, ARE LIMITED TO THE NINETY (90) DAY PERIOD DESCRIBED ABOVE. IN NO EVENT WILL SUNSOFT BE LIABLE FOR ANY SPECIAL, INCIDENTAL, OR CONSEQUENTIAL DAMAGES RESULTING FROM POSSESSION, USE OR MALFUNCTION OF THIS SUNSOFT SOFTWARE PRODUCT.**

Some states do not allow limitations as to how long an implied warranty lasts and/or exclusions or limitations or incidental or consequential damages so the above limitations and/or exclusions of liability may not apply to you. This warranty gives you specific rights, and you may also have other rights which vary from state to state.

SUNSOFT, USA, 3151 AIRWAY AVENUE, SUITE F-109, COSTA MESA, CA 92626
TEL: 714 850 2700 FAX: 714 850 2710, Web : www.sunsoft-games.com



Sunsoft is a registered trademark of Sun Corporation

©1999 Sunsoft.

©1999 NK System.

SUNSOFT, USA

3151 AIRWAY AVENUE, SUITE F-109, COSTA MESA, CA 92626

TEL: 714 850 2700 FAX: 714 850 2710



Licensed by Sony Computer Entertainment America for use with the PlayStation game console. PlayStation and the PlayStation logos are registered trademarks of Sony Computer Entertainment Inc. Dual Shock is a trademark of Sony Computer Entertainment Inc. The ratings icon is a trademark of the Interactive Digital Software Association. Manufactured and printed in the U.S.A. THIS SOFTWARE IS COMPATIBLE WITH PLAYSTATION GAME CONSOLES WITH THE NTSC U/C DESIGNATION. U.S. AND FOREIGN PATENTS PENDING.

SUNSOFT